

Silicon Diffused Power Transistor

BU2527DF

GENERAL DESCRIPTION

New generation, high-voltage, high-speed switching npn transistor with integrated damper diode in a plastic full-pack envelope intended for use in horizontal deflection circuits of high resolution monitors. Features improved RBSOA performance.

QUICK REFERENCE DATA

| SYMBOL | PARAMETER | CONDITIONS | TYP. | MAX. | UNIT |
|-------------|---------------------------------------|--|------|------|---------------|
| V_{CESM} | Collector-emitter voltage peak value | $V_{BE} = 0\text{ V}$ | - | 1500 | V |
| V_{CEO} | Collector-emitter voltage (open base) | | - | 800 | V |
| I_C | Collector current (DC) | | - | 12 | A |
| I_{CM} | Collector current peak value | | - | 30 | A |
| P_{tot} | Total power dissipation | $T_{hs} \leq 25\text{ }^\circ\text{C}$ | - | 45 | W |
| V_{CESat} | Collector-emitter saturation voltage | $I_C = 8.0\text{ A}; I_B = 1.6\text{ A}$ | - | 5.0 | V |
| I_{Csat} | Collector saturation current | $f = 64\text{ kHz}$ | 6.0 | - | A |
| t_s | Storage time | $I_{Csat} = 6.0\text{ A}; f = 64\text{ kHz}$ | 1.7 | 2.0 | μs |

PINNING - SOT199

| PIN | DESCRIPTION |
|------|-------------|
| 1 | base |
| 2 | collector |
| 3 | emitter |
| case | isolated |

PIN CONFIGURATION

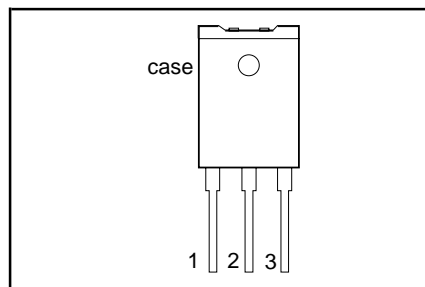

SYMBOL

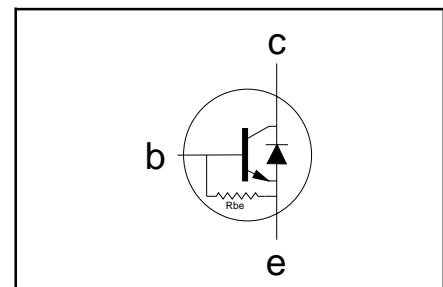

LIMITING VALUES

Limiting values in accordance with the Absolute Maximum Rating System (IEC 134)

| SYMBOL | PARAMETER | CONDITIONS | MIN. | MAX. | UNIT |
|--------------|--|--|------|------|------------------|
| V_{CESM} | Collector-emitter voltage peak value | $V_{BE} = 0\text{ V}$ | - | 1500 | V |
| V_{CEO} | Collector-emitter voltage (open base) | | - | 800 | V |
| I_C | Collector current (DC) | | - | 12 | A |
| I_{CM} | Collector current peak value | | - | 30 | A |
| I_B | Base current (DC) | | - | 8 | A |
| I_{BM} | Base current peak value | | - | 12 | A |
| $-I_{B(AV)}$ | Reverse base current | average over any 20 ms period | - | 200 | mA |
| $-I_{BM}$ | Reverse base current peak value ¹ | | - | 7 | A |
| P_{tot} | Total power dissipation | $T_{hs} \leq 25\text{ }^\circ\text{C}$ | - | 45 | W |
| T_{stg} | Storage temperature | | -65 | 150 | $^\circ\text{C}$ |
| T_j | Junction temperature | | - | 150 | $^\circ\text{C}$ |

THERMAL RESISTANCES

| SYMBOL | PARAMETER | CONDITIONS | TYP. | MAX. | UNIT |
|----------------|----------------------|---------------------------|------|------|------|
| $R_{th\ j-hs}$ | Junction to heatsink | without heatsink compound | - | 3.7 | K/W |
| $R_{th\ j-hs}$ | Junction to heatsink | with heatsink compound | - | 2.8 | K/W |
| $R_{th\ j-a}$ | Junction to ambient | in free air | 35 | - | K/W |

¹ Turn-off current.

Silicon Diffused Power Transistor

BU2527DF

ISOLATION LIMITING VALUE & CHARACTERISTIC

 $T_{hs} = 25\text{ }^{\circ}\text{C}$ unless otherwise specified

| SYMBOL | PARAMETER | CONDITIONS | MIN. | TYP. | MAX. | UNIT |
|------------|---|---------------------------------------|------|------|------|------|
| V_{isol} | Repetitive peak voltage from all three terminals to external heatsink | R.H. $\leq 65\%$; clean and dustfree | - | | 2500 | V |
| C_{isol} | Capacitance from T2 to external heatsink | $f = 1\text{ MHz}$ | - | 22 | - | pF |

STATIC CHARACTERISTICS

 $T_{hs} = 25\text{ }^{\circ}\text{C}$ unless otherwise specified

| SYMBOL | PARAMETER | CONDITIONS | MIN. | TYP. | MAX. | UNIT |
|---------------|--|--|------|------|------|----------|
| I_{CES} | Collector cut-off current ² | $V_{BE} = 0\text{ V}; V_{CE} = V_{CESMmax}$ | - | - | 1.0 | mA |
| I_{CES} | | $V_{BE} = 0\text{ V}; V_{CE} = V_{CESMmax}$ $T_j = 125\text{ }^{\circ}\text{C}$ | - | - | 2.0 | mA |
| I_{EBO} | Emitter cut-off current | $V_{EB} = 6.0\text{ V}; I_C = 0\text{ A}$ | - | 110 | - | mA |
| R_{EB} | Base-emitter resistance | $V_{EB} = 6.0\text{ V}$ | - | 55 | - | Ω |
| BV_{EBO} | Emitter-base breakdown voltage | $I_B = 600\text{ mA}$ | 7.5 | 13.5 | - | V |
| $V_{CEOsust}$ | Collector-emitter sustaining voltage | $I_B = 0\text{ A}; I_C = 100\text{ mA};$ $L = 25\text{ mH}$ | 800 | - | - | V |
| V_{CEsat} | Collector-emitter saturation voltage | $I_C = 8.0\text{ A}; I_B = 1.6\text{ A}$ | - | - | 5.0 | V |
| V_{BEsat} | Base-emitter saturation voltage | $I_C = 8.0\text{ A}; I_B = 1.6\text{ A}$ | - | - | 1.1 | V |
| h_{FE} | DC current gain | $I_C = 1\text{ A}; V_{CE} = 5\text{ V}$ | - | 11 | - | |
| h_{FE} | | $I_C = 8\text{ A}; V_{CE} = 5\text{ V}$ | 5 | 7 | 10 | |
| V_F | Diode forward voltage | $I_F = 8\text{ A}$ | - | 1.6 | 2.0 | V |

DYNAMIC CHARACTERISTICS

 $T_{hs} = 25\text{ }^{\circ}\text{C}$ unless otherwise specified

| SYMBOL | PARAMETER | CONDITIONS | TYP. | MAX. | UNIT |
|----------|--|---|------|------|---------------|
| C_c | Collector capacitance | $I_E = 0\text{ A}; V_{CB} = 10\text{ V}; f = 1\text{ MHz}$ | 145 | - | pF |
| | Switching times (64 kHz line deflection circuit) | $I_{Csat} = 6.0\text{ A}; L_C = 170\text{ }\mu\text{H};$ $C_{fb} = 5.4\text{ nF}; I_{B(end)} = 0.55\text{ A};$ $L_B = 0.6\text{ }\mu\text{H}; -V_{BB} = 4\text{ V}; -I_{BM} = 3.6\text{ A}$ | | | |
| t_s | Turn-off storage time | | 1.7 | 2.0 | μs |
| t_f | Turn-off fall time | | 0.1 | 0.2 | μs |
| V_{fr} | Anti-parallel diode forward recovery voltage | $I_F = 8\text{ A}; dI_F/dt = 50\text{ A}/\mu\text{s}$ | 16 | - | V |
| t_{fr} | Anti-parallel diode forward recovery time | $V_F = 5\text{ V}$ | 410 | - | ns |

² Measured with half sine-wave voltage (curve tracer).

Silicon Diffused Power Transistor

BU2527DF

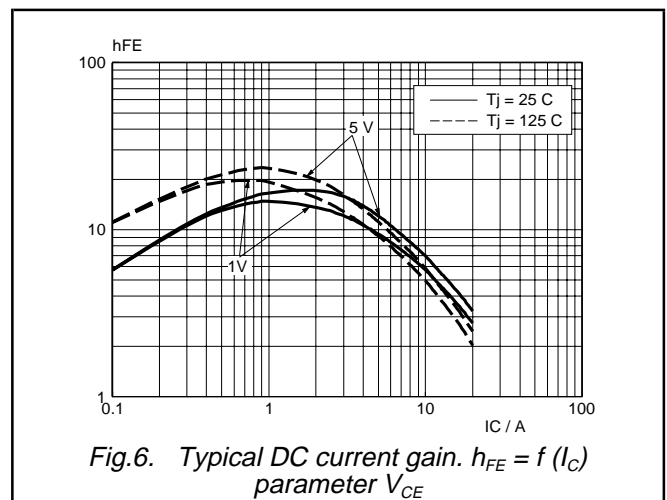
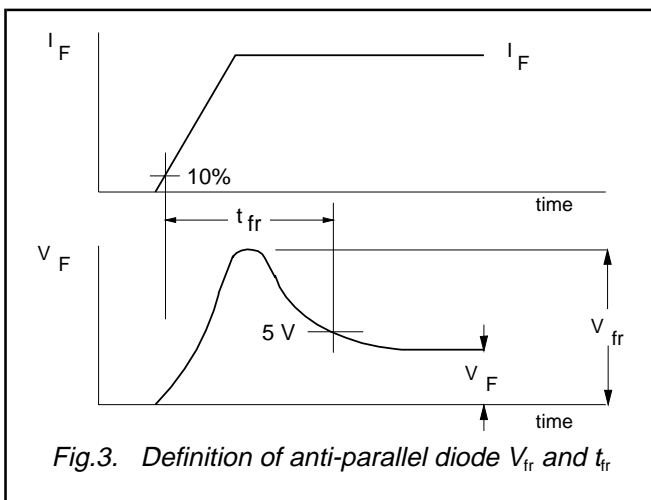
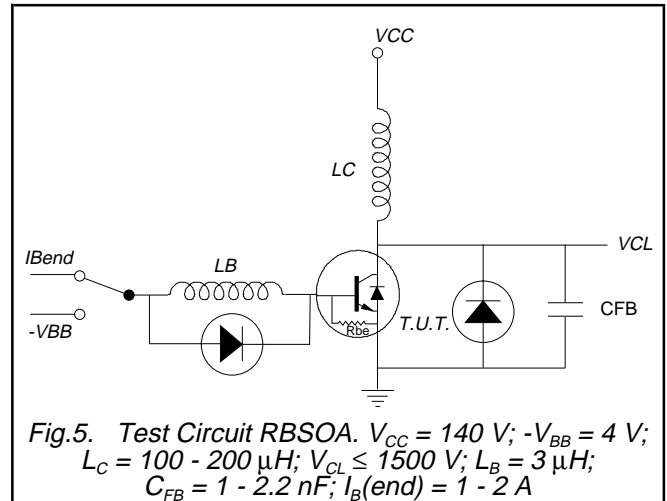
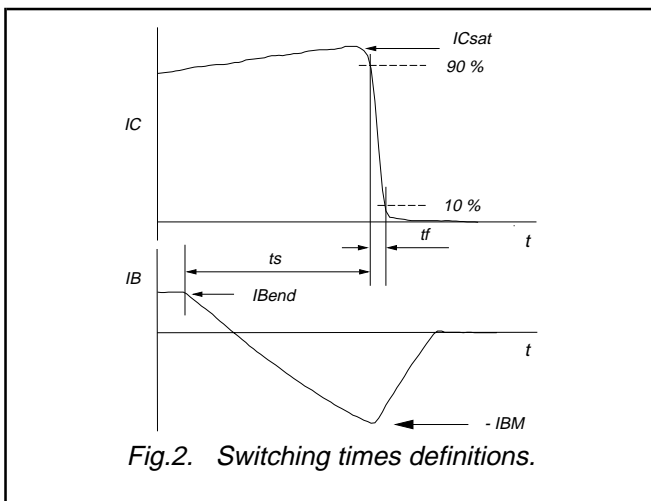
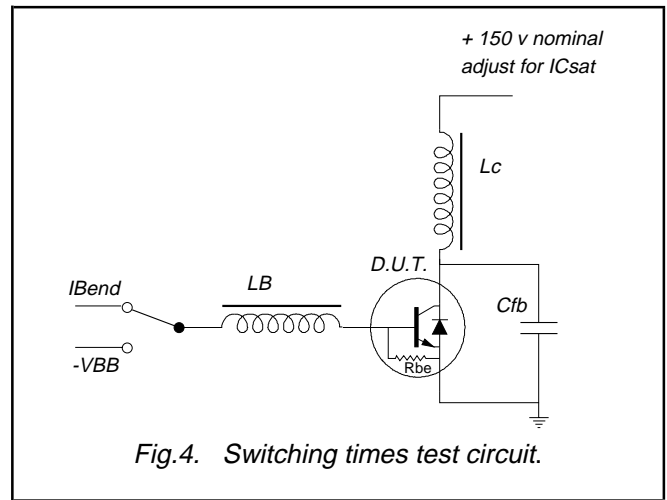
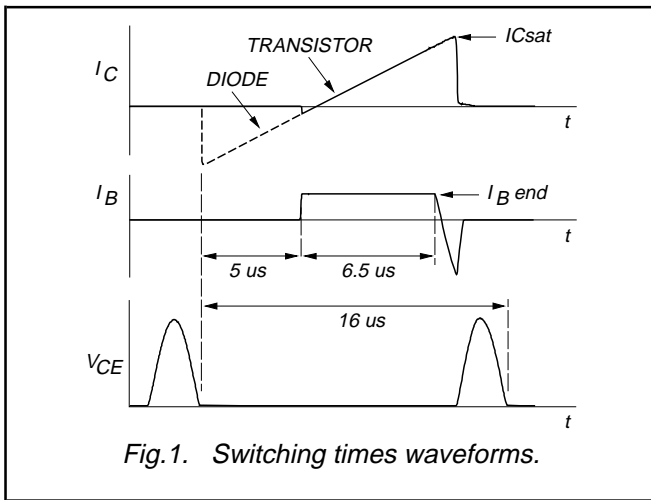

Silicon Diffused Power Transistor

BU2527DF

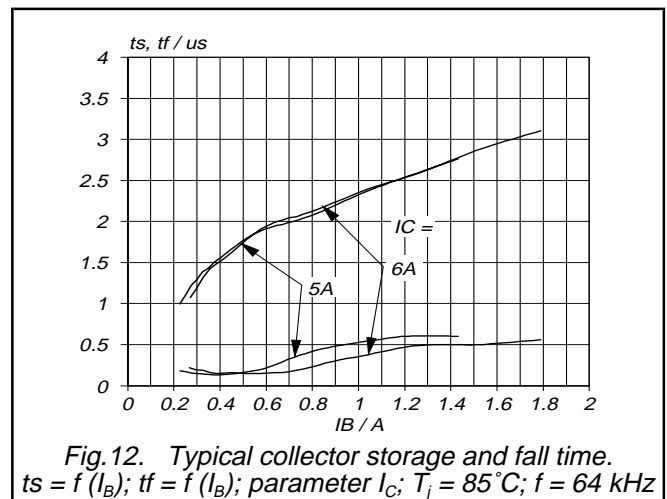
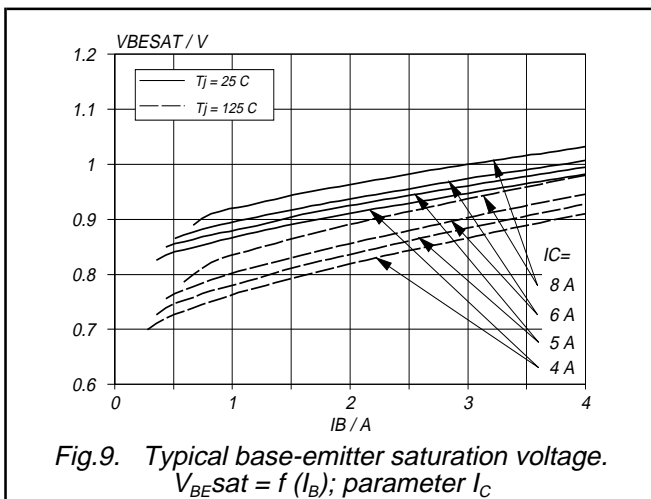
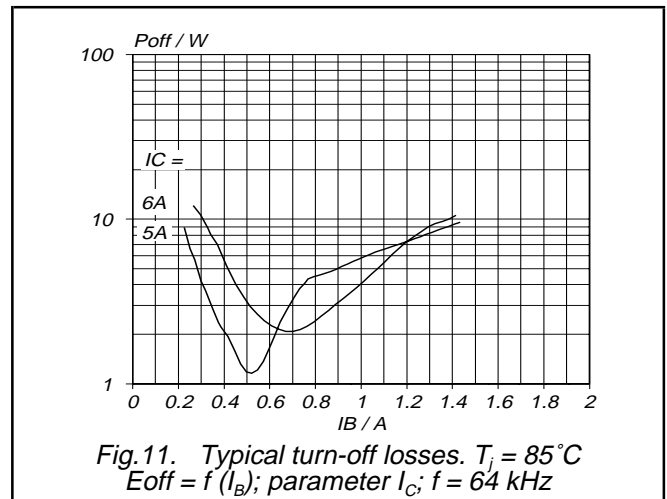
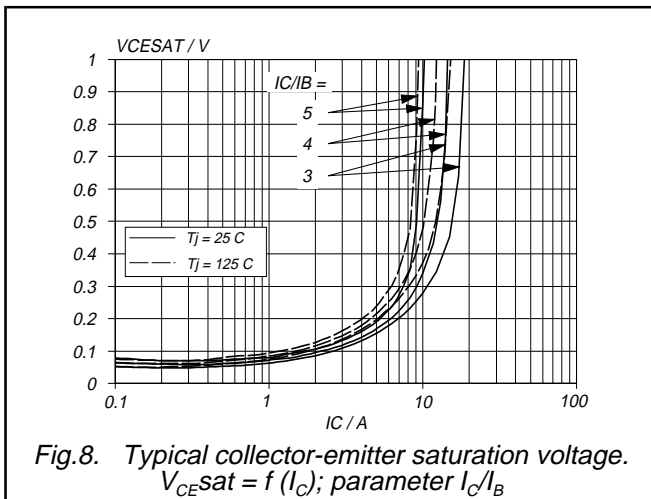
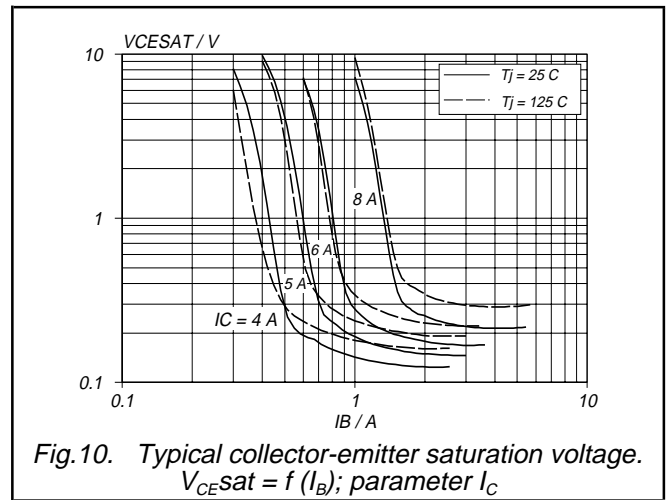
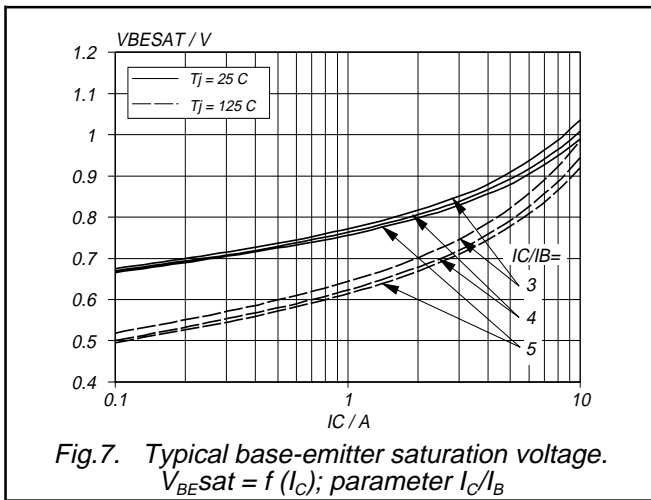

Silicon Diffused Power Transistor

BU2527DF

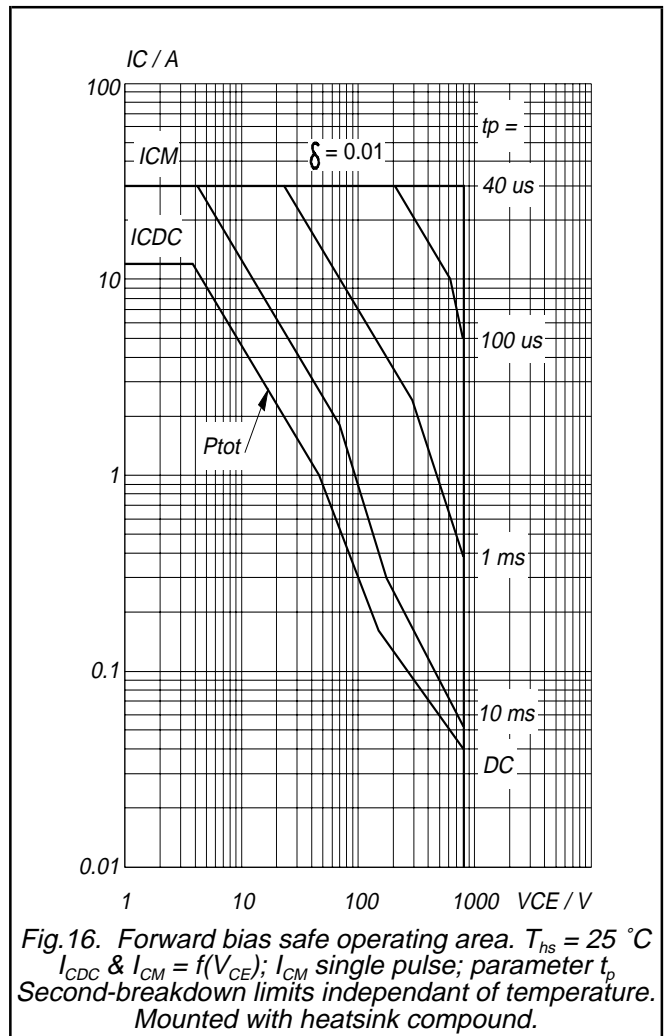
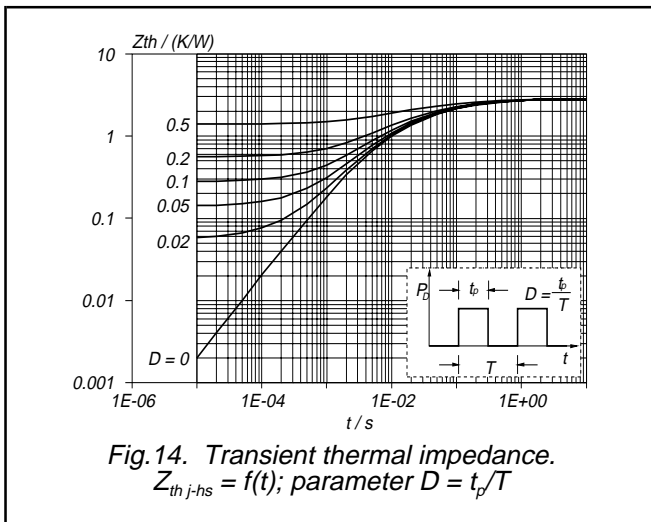
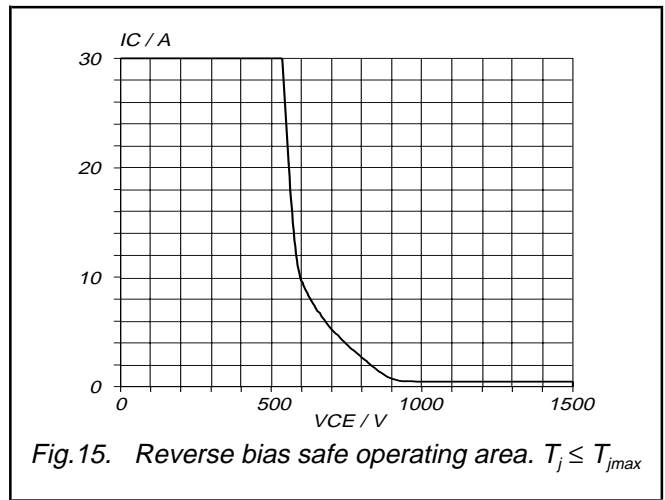

Silicon Diffused Power Transistor

BU2527DF

DEFINITIONS

| | |
|--|---|
| Data sheet status | |
| Objective specification | This data sheet contains target or goal specifications for product development. |
| Preliminary specification | This data sheet contains preliminary data; supplementary data may be published later. |
| Product specification | This data sheet contains final product specifications. |
| Limiting values | |
| Limiting values are given in accordance with the Absolute Maximum Rating System (IEC 134). Stress above one or more of the limiting values may cause permanent damage to the device. These are stress ratings only and operation of the device at these or at any other conditions above those given in the Characteristics sections of this specification is not implied. Exposure to limiting values for extended periods may affect device reliability. | |
| Application information | |
| Where application information is given, it is advisory and does not form part of the specification. | |
| © Philips Electronics N.V. 1997 | |
| All rights are reserved. Reproduction in whole or in part is prohibited without the prior written consent of the copyright owner. | |
| The information presented in this document does not form part of any quotation or contract, it is believed to be accurate and reliable and may be changed without notice. No liability will be accepted by the publisher for any consequence of its use. Publication thereof does not convey nor imply any license under patent or other industrial or intellectual property rights. | |

LIFE SUPPORT APPLICATIONS

These products are not designed for use in life support appliances, devices or systems where malfunction of these products can be reasonably expected to result in personal injury. Philips customers using or selling these products for use in such applications do so at their own risk and agree to fully indemnify Philips for any damages resulting from such improper use or sale.